

Technical data sheet

Locknut, PG thread

Item number: 2091070



Locknuts, part M to DIN 46320 with Pg thread to DIN 40430. * Price according to DEL notation.



CuZn
37 Brass

N Nickel-plated

Master data

Item number	2091070
Type	169 MS PG 7
Description 1	Locknut
Manufacturer	OBO
Dimension	PG7
Material	Brass
Surface	Nickel-plated
Surface standard	
Smallest sales unit	100
Unit of quantity	Units
Weight	0,18 kg
Weight unit	kg/100 pairs

Technical data sheet

Locknut, PG thread

Item number: 2091070



Dimensions

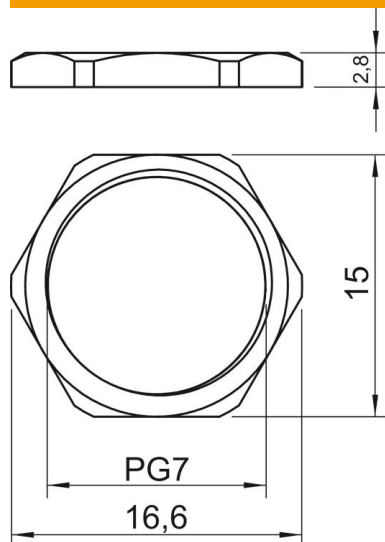

Dimension E	16,6 mm
Dimension L	2,8 mm

Technical specifications

Thread	Pg_7
Thread type	Pg
Nominal thread size metric/PG	7
Fibre-glass reinforced	no
Halogen-free	no
Impact-resistant	no
WAF	15