

Technical data sheet

Reduction, metric thread

Item number: 2089580

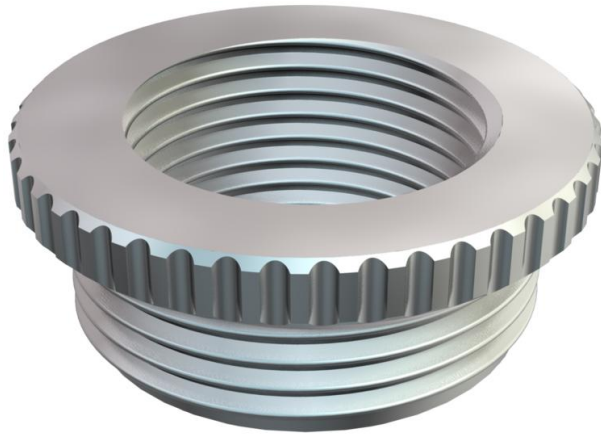

Reduction (Part H) in accordance with DIN 46320, with metric thread to DIN EN 60423 or ISO 68.

* Prices according to DEL notation.



CuZn
37 Brass

N Nickel-plated

Master data

Item number	2089580
Type	167 R MS M40-25
Description 1	Reduction
Manufacturer	OBO
Dimension	M40-M25
Material	Brass
Surface	Nickel-plated
Surface standard	
Smallest sales unit	25
Unit of quantity	Units
Weight	9,96 kg
Weight unit	kg/100 pairs

Technical data sheet

Reduction, metric thread

Item number: 2089580



Dimensions

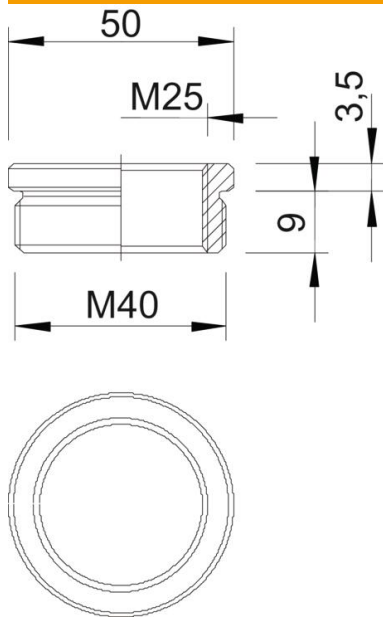

Dimension D	50 mm
Dimension L1	9 mm
Dimension L2	3,5 mm

Technical specifications

explosion-proof	no
Thread type: External thread	Metric
Thread type: Internal thread	Metric
Thread length	6 mm
Thread dimension, metric, external	40
Thread dimension, metric, internal	25
Nickel-plated	yes