

Technical data sheet

Reduction, metric thread

Item number: 2030619

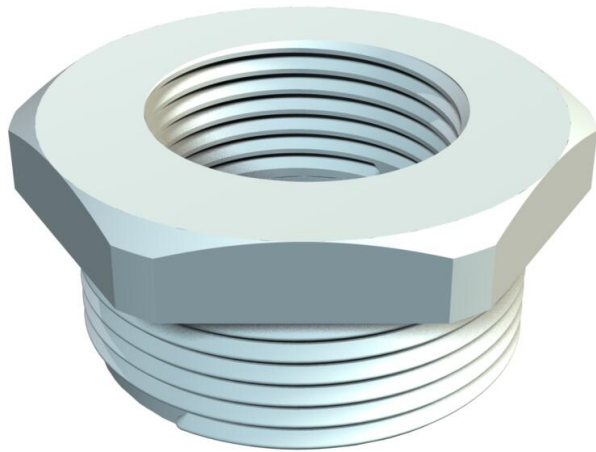

Reduction, with metric internal and external thread.



PA Polyamide

Master data

Item number	2030619
Type	107 R M20-16 PA
Description 1	Reduction
Manufacturer	OBO
Dimension	M20-M16
Colour	Light grey; RAL 7035
Material	Polyamide
Smallest sales unit	100
Unit of quantity	Units
Weight	0,7 kg
Weight unit	kg/100 pairs

Technical data sheet

Reduction, metric thread

Item number: 2030619



Dimensions

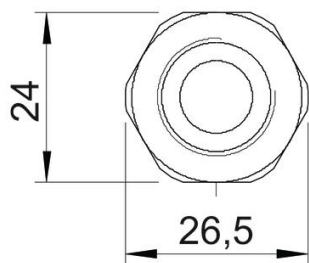
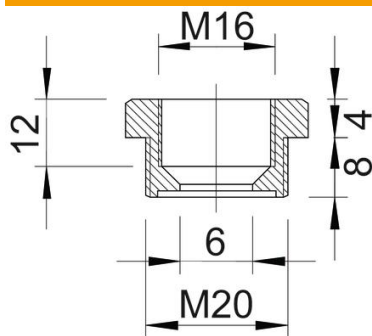

Dimension E	26,5 mm
Dimension L	12 mm
Dimension L1	8 mm
Dimension L2	4 mm
Dimension L3	12 mm

Technical specifications

explosion-proof	no
Thread type: External thread	Metric
Thread type: Internal thread	Metric
Thread length	8 mm
Thread dimension, metric, external	20
Thread dimension, metric, internal	16
Halogen-free	yes
WAF	24
Nickel-plated	no