

# Technical data sheet

## Junction box T 40, plug-in seal, terminal strip

Item number: 2007432



Junction box with terminal strip for the connection of cables and lines indoors and in protected outdoor areas. Square design with plug-in seals to the sides and knock-out entries in the bottom. Suitable for wall and ceiling mounting and on mounting panels. With the option to fasten inside. With fixed clamping cover. Made from halogen-free, UV-resistant materials.

Junction box according to DIN EN 60670. Flame-resistant to DIN EN 60695/2/11, test temperature 650°C. Impact resistance IK07 according to DIN EN 50102.



**PP** Polypropylene

### Master data

Item number	2007432
Type	T 40 KL
Description 1	Junction box
Description 2	with terminal strip + entries
Manufacturer	OBO
Dimension	90x90x52
Colour	Light grey; RAL 7035
Material	Polypropylene
Smallest sales unit	5
Unit of quantity	Piece
Weight	8.9 kg
Weight unit	kg/100 pc.

# Technical data sheet

## Junction box T 40, plug-in seal, terminal strip

Item number: 2007432



### Dimensions

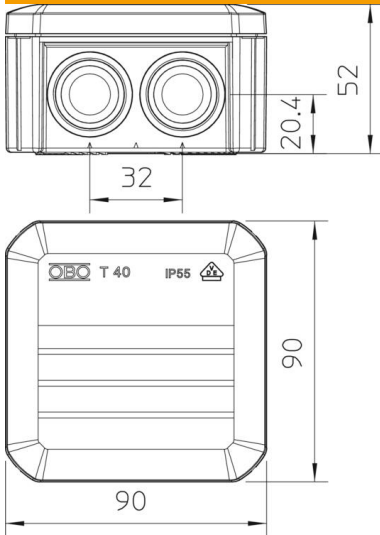

Length	90 mm
Width	90 mm
Height	52 mm

### Technical data

Expandable	yes
No. of entries	7
Number of terminals	5
Type of insertion...	Plug-in seal
Type of entry	Cable
Type of housing penetration	Cuttable stepped membrane
Measured insulation voltage $V_i$	500 V
Equipment	Terminal
Cover	Not transparent
Cover fastening	Locking
Entry from rear	yes
Entries	7 x M25
Explosion-tested version	no
Flame-resistant	acc. to VDE 0471/DIN 695 Part 2-1, test temperature 650°C
Shape	Square
Maintain electrical functions	Without
For Ex zone	Without
For Ex zone gas	Without
For Ex zone dust	Without
Fibre-glass reinforced	no
Halogen-free	yes
Clear internal dimensions	77x77x46 mm
With screening	no
with lid	yes
Mounting type	Wall/ceiling mounting
Nominal cross-section, min.	4 mm <sup>2</sup>
Nominal voltage	500 V
Sealable	no
Protection rating	IP55

# Technical data sheet

Junction box T 40, plug-in seal, terminal strip

Item number: 2007432



## Technical data

Protection rating IK code	IK07.
Permitted temperature range, max.	60 °C
Permitted temperature range, min.	-5 °C
Weatherproof	no