

Technical data sheet

90° bend 35 FS

Item number: 6036502



90° bend for the creation of a horizontal branch, fitting for lock and screw-on cable trays of side height 35 mm. Screw connection with FRS truss-head screws and M6 combination nuts. Can be used in indoor areas. Fastening material must be ordered separately.



St Steel

FS Strip galvanized

Master data

Item number	6036502
Type	RB 90 320 FS
Description 1	90° bend
Description 2	for cable tray, horizontal
Manufacturer	OBO
Dimension	35x200
Material	Steel
Surface	Strip galvanized
Surface standard	DIN EN 10346
Smallest sales unit	1
Unit of quantity	Piece
Weight	77.8 kg
Weight unit	kg/100 pc.

Technical data sheet

90° bend 35 FS

Item number: 6036502



Dimensions

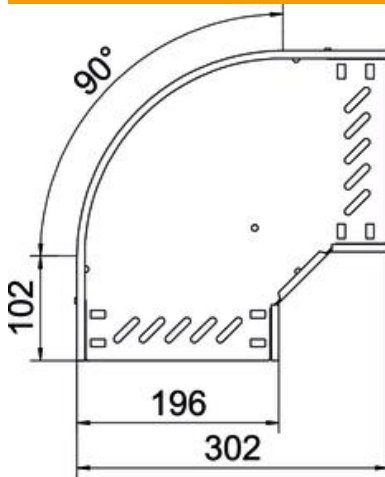

Width	200 mm
Height	35 mm
Plate thickness	0.8 mm
Dimension B	200 mm

Technical data

Bend (angle)	90°
Connector version	Integrated connector
Type	Bend, rigid
Maintain electrical functions	no
Material thickness, floor plate	0.8 mm
With cover	no
Mounting perforation in base	yes
NATO hole pattern	no
Change of direction	Horizontal
Rustproof steel, pickled	no
Side perforation	yes
Permitted temperature range, max.	120 °C
Permitted temperature range, min.	-20 °C
Wide-span version	no
Type of connector, cable support system	Screwed
Recommended quantity of bolts	8 St.
Rail thickness	1.25 mm