

Technical data sheet

90° Magic bend 110 FT SOMY

Item number: 7196107

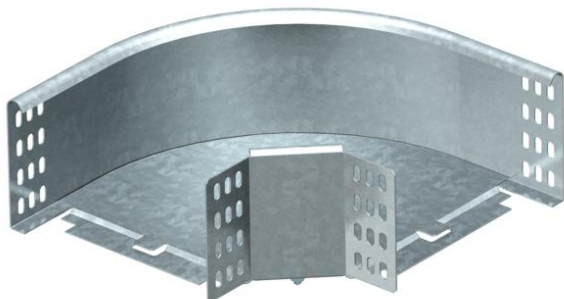

90° bend, horizontal, for all cable tray types of 110 mm side height.
The fitting is shipped in an unmounted state.
Including appropriate fastening material.



St	Steel
FT SO	Hot-dip galvanised 85 µm

Master data

Item number	7196107
Type	RB 90 120 FT SO
Description 1	90° bend
Description 2	horizontal + angle connector
Manufacturer	OBO
Dimension	110x200
Material	Steel
Surface	Hot-dip galvanised 85 µm
Surface standard	DIN EN ISO 1461
Smallest sales unit	1
Unit of quantity	Piece
Weight	167 kg
Weight unit	kg/100 pc.

Dimensions

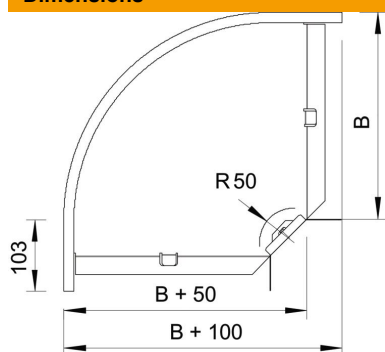

Width	200 mm
Height	110 mm
Dimension B	200 mm
Dimension R	50 mm

Technical data sheet

90° Magic bend 110 FT SOMY

Item number: 7196107



Technical data

Bend (angle)	90°
Connector version	Supplied connectors
Change of direction	Horizontal
Type of connector, cable support system	Screwed