

# Technical data sheet

## Counter-trough, metal universal, DD

Item number: 1199889



Metal counter-trough, for mounting on clamp clip. Can be used universally, irrespective of the rail.



**St** Steel

**DD** Strip galvanised zinc/aluminium, Double Dip

### Master data

Item number	1199889
Type	2058FW M 34 DD
Description 1	Counter-trough
Manufacturer	OBO
Dimension	28-34mm
Material	Steel
Surface	Strip galvanised zinc/aluminium, Double Dip
Surface standard	DIN EN 10346
Smallest sales unit	100
Unit of quantity	Piece
Weight	2.16 kg
Weight unit	kg/100 pc.

# Technical data sheet

## Counter-trough, metal universal, DD

Item number: 1199889



### Dimensions



Dimension B	40 mm
Dimension H	13.5 mm
Dimension L	35 mm

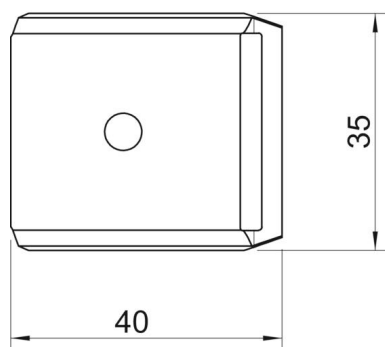

### Technical data

Counter-trough/clip version	Counter sleeve
Suitable for max. cable diameter	34 mm
Halogen-free	yes
Clamping range D, max.	34 mm
Clamping range D, min.	28 mm